

# Field Guide

MF5 Metal and Conductive Detector

# MF5

## MF5 Unfolding Procedure

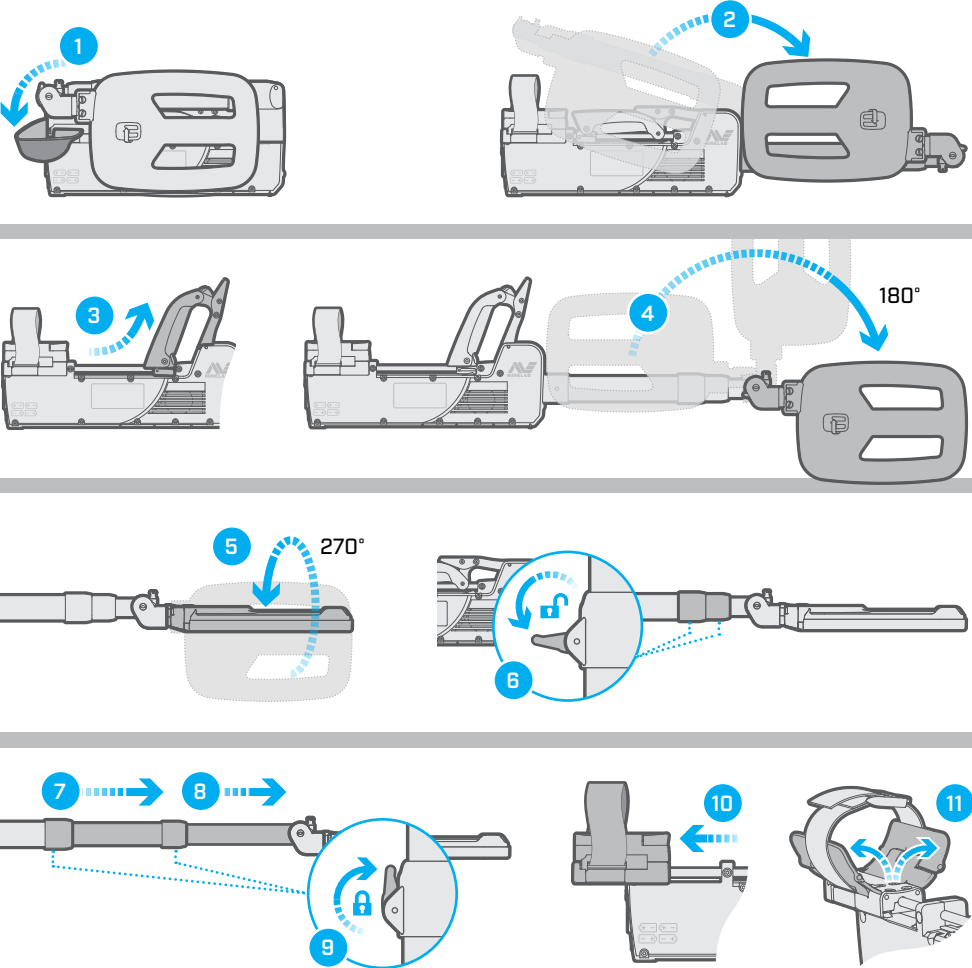

### Pack Up

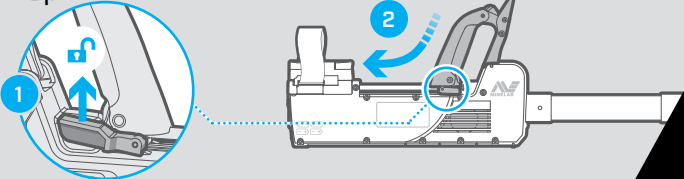

# Factory Reset

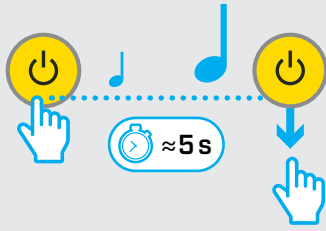

# Quick Start

## 1. Turn On



## 2. Ground Balance

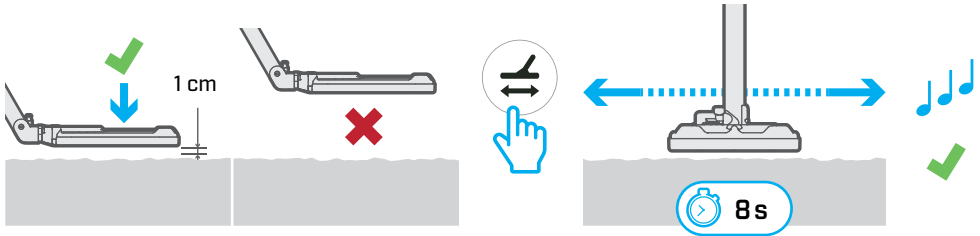

## 3. Test Piece

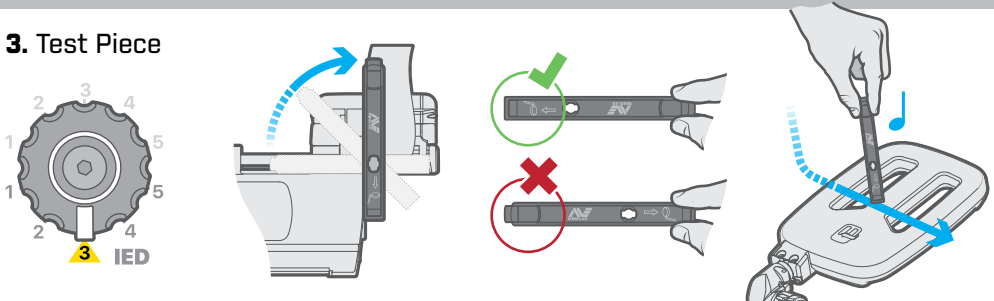

## 4. Begin Detecting

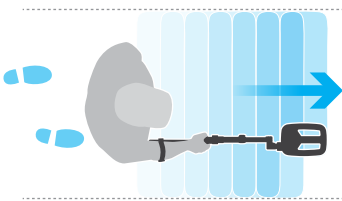

## Sensor Modes

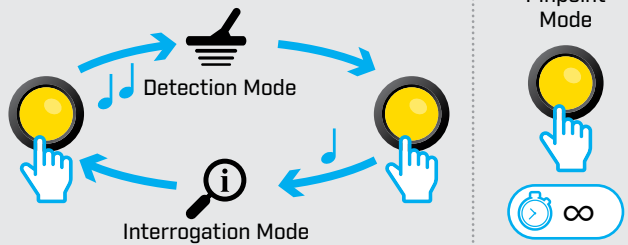

## Interrogation Mode

